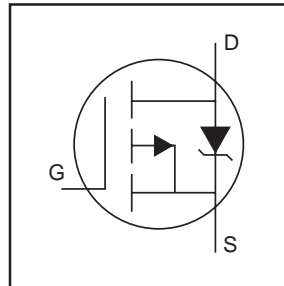


# IRFR/U5305

HEXFET® Power MOSFET

- Ultra Low On-Resistance
- Surface Mount (IRFR5305)
- Straight Lead (IRFU5305)
- Advanced Process Technology
- Fast Switching
- Fully Avalanche Rated

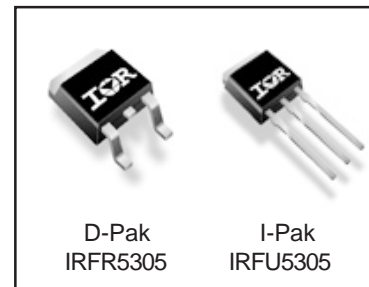


$V_{DSS} = -55V$
$R_{DS(on)} = 0.065\Omega$
$I_D = -31A$

## Description

Fifth Generation HEXFETs from International Rectifier utilize advanced processing techniques to achieve extremely low on-resistance per silicon area. This benefit, combined with the fast switching speed and ruggedized device design that HEXFET® Power MOSFETs are well known for, provides the designer with an extremely efficient and reliable device for use in a wide variety of applications.

The D-Pak is designed for surface mounting using vapor phase, infrared, or wave soldering techniques. The straight lead version (IRFU series) is for through-hole mounting applications. Power dissipation levels up to 1.5 watts are possible in typical surface mount applications.



D-Pak  
IRFR5305

I-Pak  
IRFU5305

## Absolute Maximum Ratings

	Parameter	Max.	Units
$I_D @ T_C = 25^\circ C$	Continuous Drain Current, $V_{GS} @ -10V$	-31	A
$I_D @ T_C = 100^\circ C$	Continuous Drain Current, $V_{GS} @ -10V$	-22	
$I_{DM}$	Pulsed Drain Current ①⑥	-110	
$P_D @ T_C = 25^\circ C$	Power Dissipation	110	W
	Linear Derating Factor	0.71	W/°C
$V_{GS}$	Gate-to-Source Voltage	$\pm 20$	V
$E_{AS}$	Single Pulse Avalanche Energy ②⑥	280	mJ
$I_{AR}$	Avalanche Current ①⑥	-16	A
$E_{AR}$	Repetitive Avalanche Energy ①	11	mJ
dv/dt	Peak Diode Recovery dv/dt ③⑥	-5.0	V/ns
$T_J$	Operating Junction and	-55 to + 175	°C
$T_{STG}$	Storage Temperature Range		
	Soldering Temperature, for 10 seconds		
	Mounting torque, 6-32 or M3 screw	10 lbf•in (1.1N•m)	

## Thermal Resistance

	Parameter	Typ.	Max.	Units
$R_{\theta JC}$	Junction-to-Case	—	1.4	°C/W
$R_{\theta JA}$	Junction-to-Ambient (PCB mount)*	—	50	
$R_{\theta JA}$	Junction-to-Ambient**	—	110	

## Electrical Characteristics @ $T_J = 25^\circ\text{C}$ (unless otherwise specified)

	Parameter	Min.	Typ.	Max.	Units	Conditions
	$V_{(BR)DSS}$	-55	—	—	V	$V_{GS} = 0V, I_D = -250\mu A$
	$\Delta V_{(BR)DSS}/\Delta T_J$	—	-0.034	—	V/°C	Reference to $25^\circ\text{C}, I_D = -1\text{mA}$
	$R_{DS(on)}$	—	—	0.065	$\Omega$	$V_{GS} = -10V, I_D = -16A$ ④
	$V_{GS(th)}$	-2.0	—	-4.0	V	$V_{DS} = V_{GS}, I_D = -250\mu A$
	$g_{fs}$	8.0	—	—	S	$V_{DS} = -25V, I_D = -16A$ ⑥
	$I_{DSS}$	—	—	-25	$\mu A$	$V_{DS} = -55V, V_{GS} = 0V$
		—	—	-250		$V_{DS} = -44V, V_{GS} = 0V, T_J = 150^\circ\text{C}$
	$I_{GSS}$	—	—	100	nA	$V_{GS} = 20V$
		—	—	-100		$V_{GS} = -20V$
	$Q_g$	—	—	63	nC	$I_D = -16A$
	$Q_{gs}$	—	—	13		$V_{DS} = -44V$
	$Q_{gd}$	—	—	29		$V_{GS} = -10V$ , See Fig. 6 and 13 ④⑥
	$t_{d(on)}$	—	14	—	ns	$V_{DD} = -28V$ $I_D = -16A$ $R_G = 6.8\Omega$ $R_D = 1.6\Omega$ , See Fig. 10 ④⑥
	$t_r$	—	66	—		
	$t_{d(off)}$	—	39	—		
	$t_f$	—	63	—		
	$L_D$	—	4.5	—	nH	Between lead, 6mm (0.25in.) from package and center of die contact ⑤
	$L_S$	—	7.5	—		
	$C_{iss}$	—	1200	—	pF	$V_{GS} = 0V$ $V_{DS} = -25V$ $f = 1.0\text{MHz}$ , See Fig. 5 ⑥
	$C_{oss}$	—	520	—		
	$C_{rss}$	—	250	—		

## Source-Drain Ratings and Characteristics

	Parameter	Min.	Typ.	Max.	Units	Conditions
	$I_S$	—	—	-31	A	MOSFET symbol showing the integral reverse p-n junction diode.
	$I_{SM}$	—	—	-110		
	$V_{SD}$	—	—	-1.3	V	$T_J = 25^\circ\text{C}, I_S = -16A, V_{GS} = 0V$ ④
	$t_{rr}$	—	71	110	ns	$T_J = 25^\circ\text{C}, I_F = -16A$
	$Q_{rr}$	—	170	250	nC	$di/dt = -100A/\mu s$ ④⑥

### Notes:

- ① Repetitive rating; pulse width limited by max. junction temperature. (See Fig. 11)
- ②  $V_{DD} = -25V$ , starting  $T_J = 25^\circ\text{C}$ ,  $L = 2.1\text{mH}$   
 $R_G = 25\Omega$ ,  $I_{AS} = -16A$ . (See Figure 12)
- ③  $I_{SD} \leq -16A$ ,  $di/dt \leq -280A/\mu s$ ,  $V_{DD} \leq V_{(BR)DSS}$ ,  
 $T_J \leq 175^\circ\text{C}$
- ④ Pulse width  $\leq 300\mu s$ ; duty cycle  $\leq 2\%$ .
- ⑤ This is applied for I-PAK,  $L_S$  of D-PAK is measured between lead and center of die contact.
- ⑥ Uses IRF5305 data and test conditions.

\* When mounted on 1" square PCB (FR-4 or G-10 Material).  
For recommended footprint and soldering techniques refer to application note #AN-994.

\*\* Uses typical socket mount.

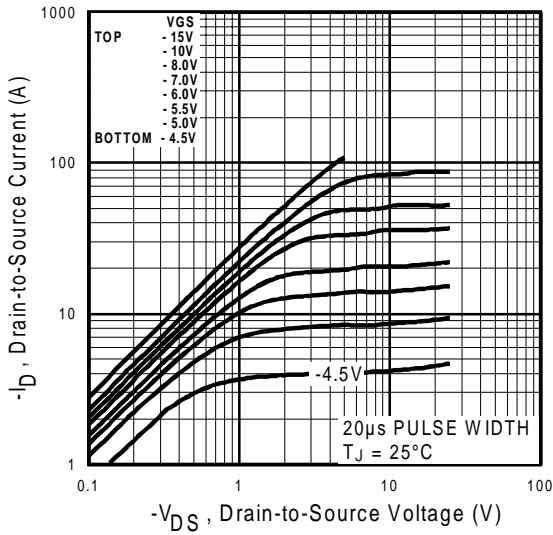


Fig 1. Typical Output Characteristics

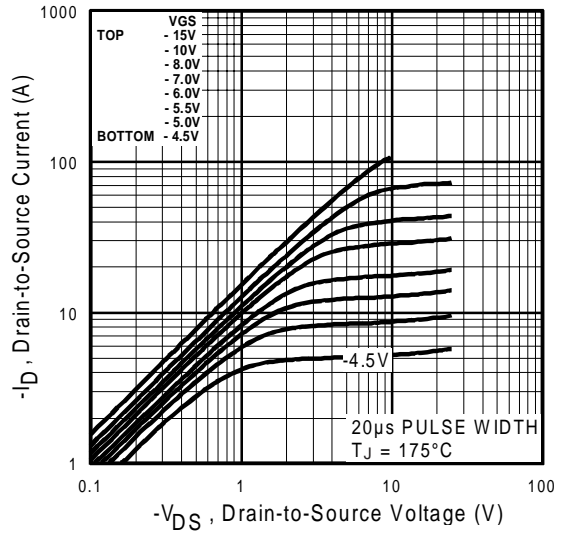


Fig 2. Typical Output Characteristics

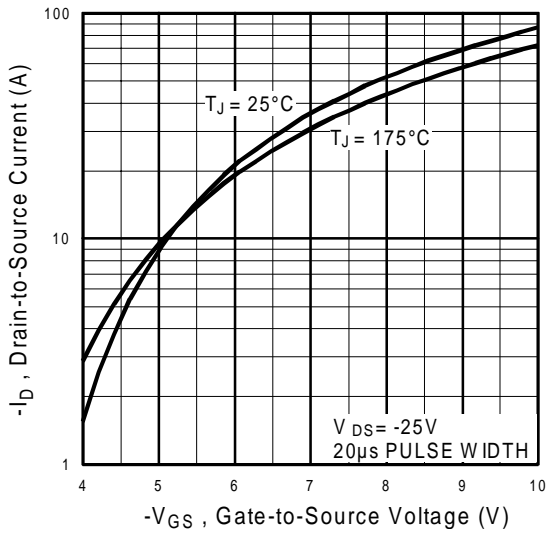


Fig 3. Typical Transfer Characteristics

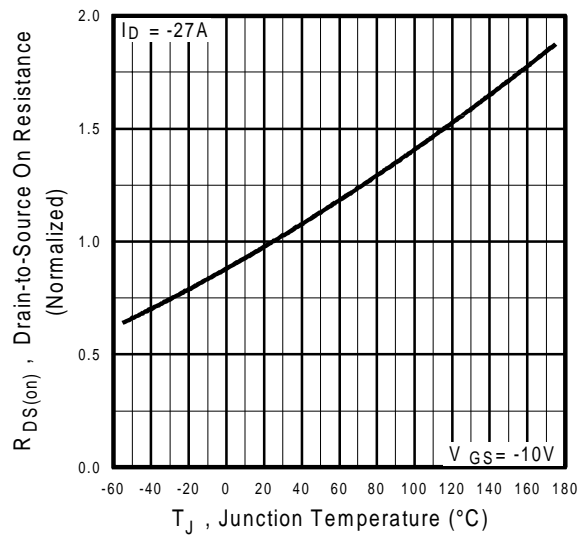
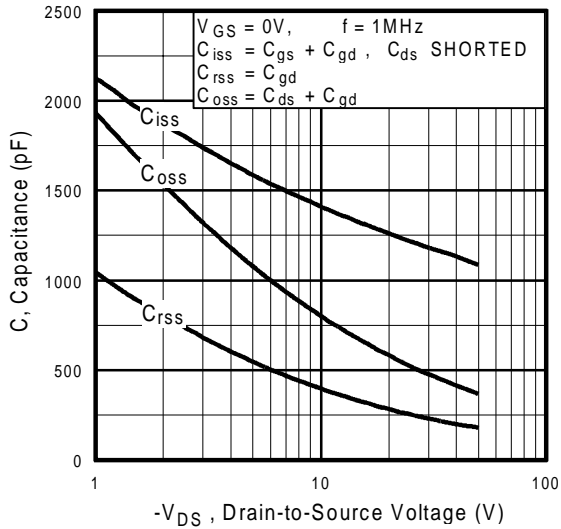
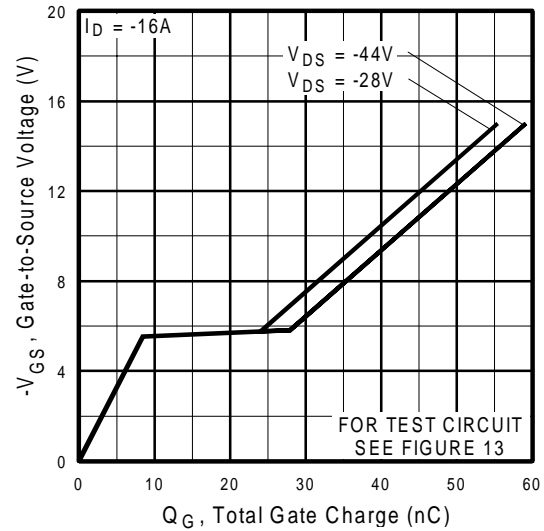


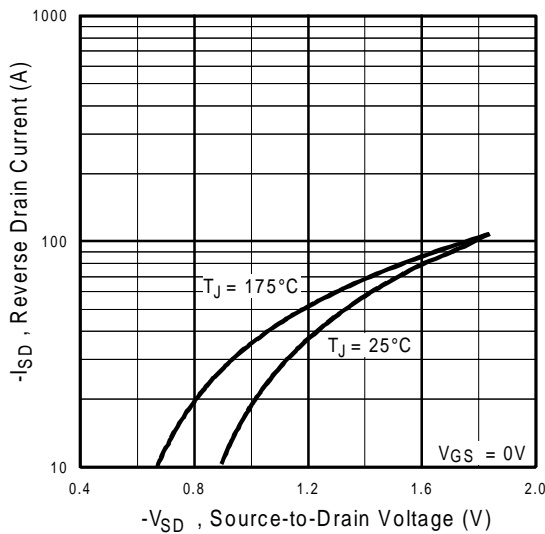
Fig 4. Normalized On-Resistance Vs. Temperature



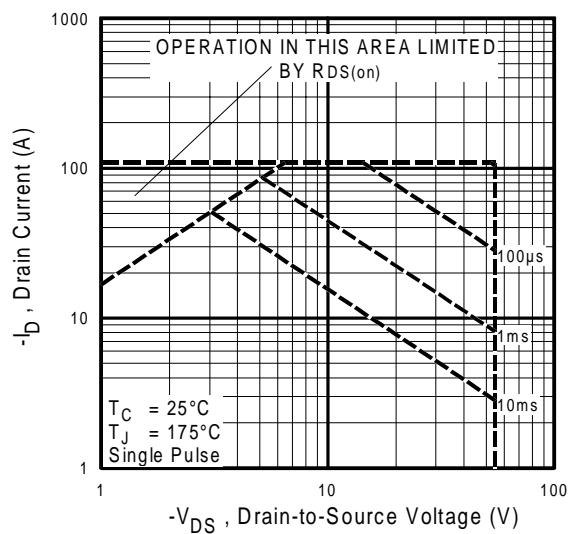
**Fig 5.** Typical Capacitance Vs. Drain-to-Source Voltage



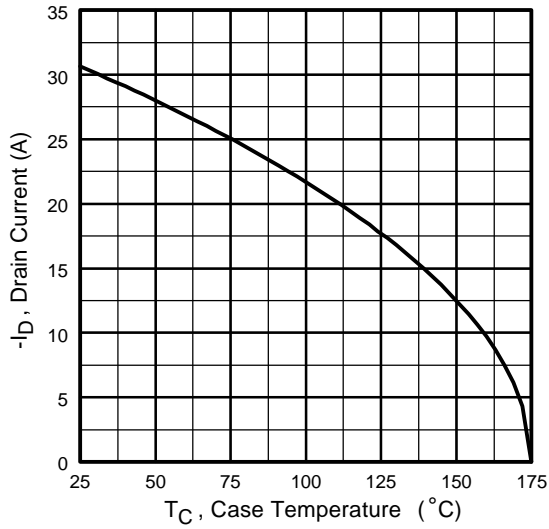
**Fig 6.** Typical Gate Charge Vs. Gate-to-Source Voltage



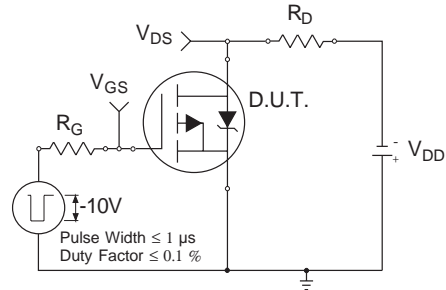
**Fig 7.** Typical Source-Drain Diode Forward Voltage



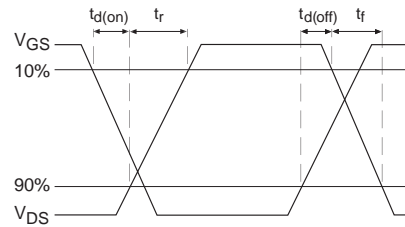
**Fig 8.** Maximum Safe Operating Area



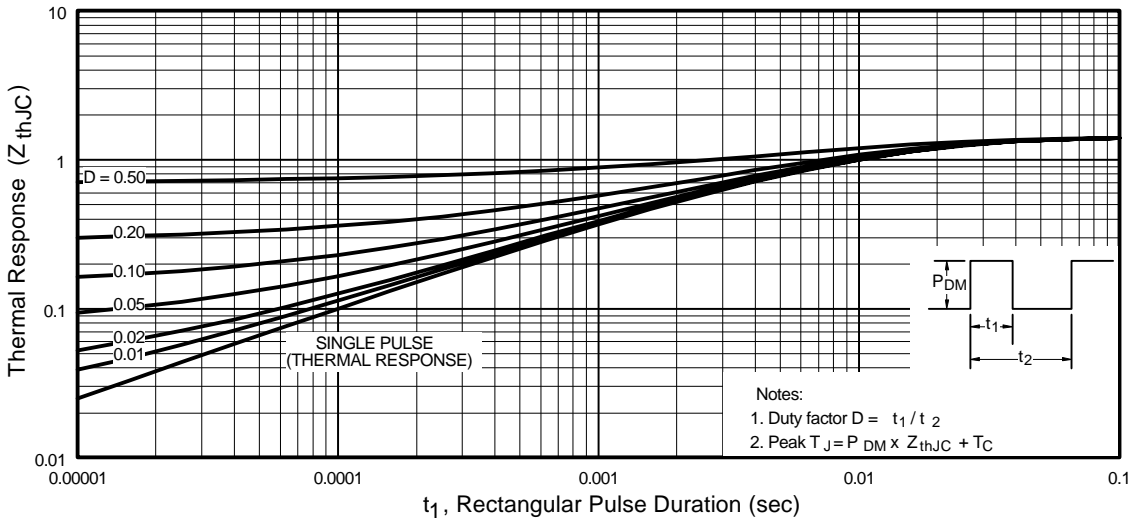
**Fig 9.** Maximum Drain Current Vs. Case Temperature



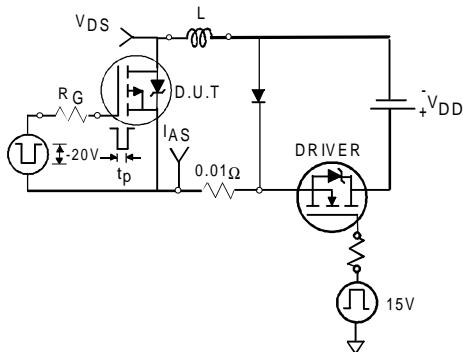
**Fig 10a.** Switching Time Test Circuit



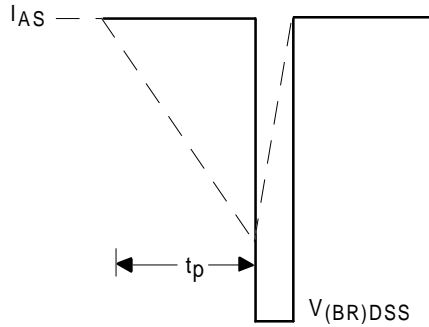
**Fig 10b.** Switching Time Waveforms



**Fig 11.** Maximum Effective Transient Thermal Impedance, Junction-to-Case



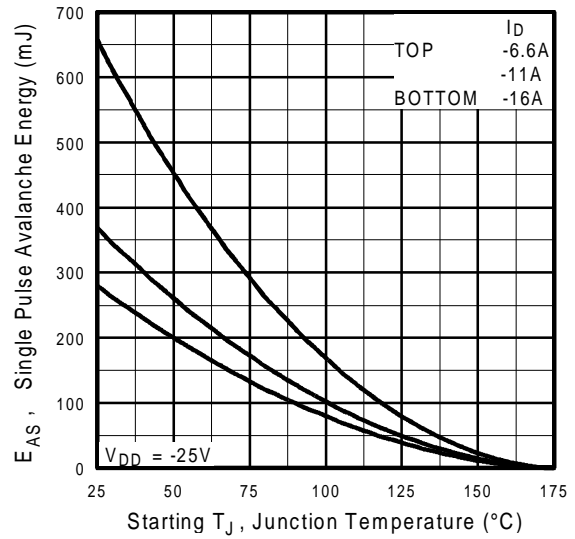
**Fig 12a.** Unclamped Inductive Test Circuit



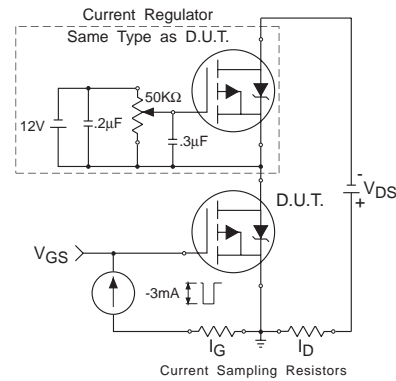
**Fig 12b.** Unclamped Inductive Waveforms



**Fig 13a.** Basic Gate Charge Waveform

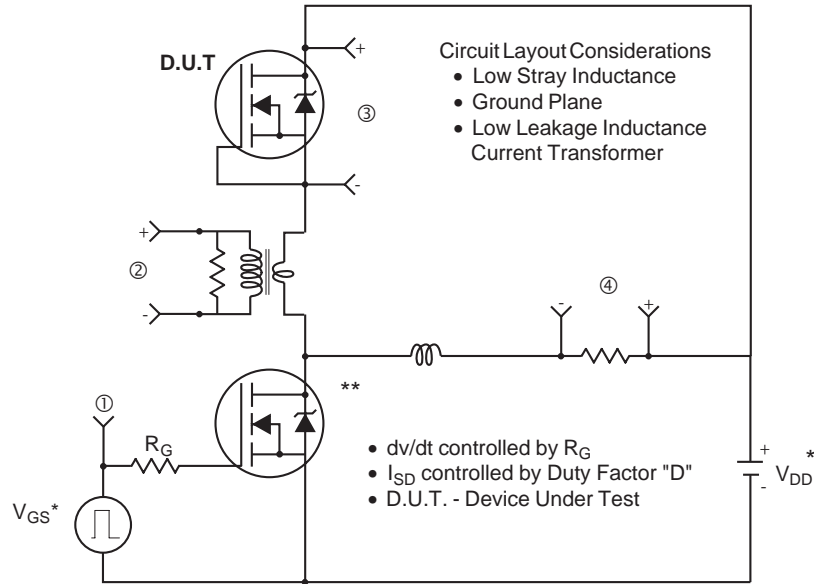


**Fig 12c.** Maximum Avalanche Energy Vs. Drain Current



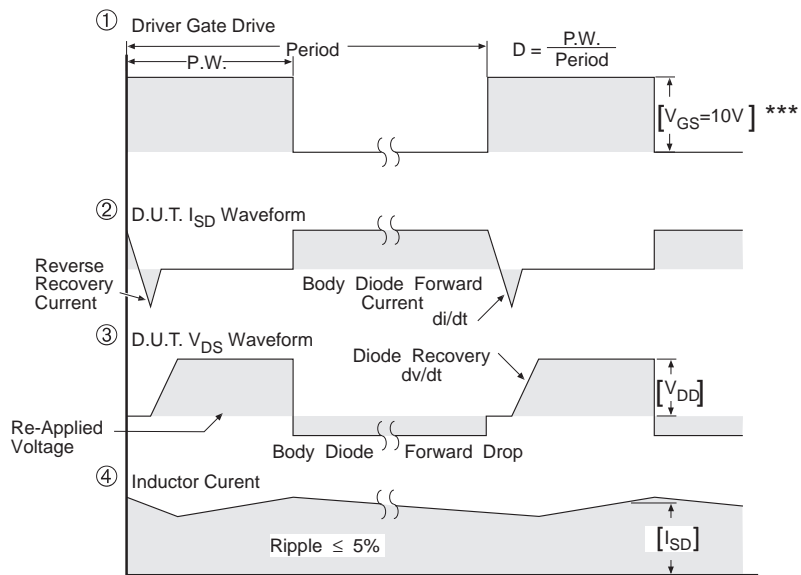
**Fig 13b.** Gate Charge Test Circuit

Peak Diode Recovery dv/dt Test Circuit



\* Reverse Polarity for P-Channel

\*\* Use P-Channel Driver for P-Channel Measurements



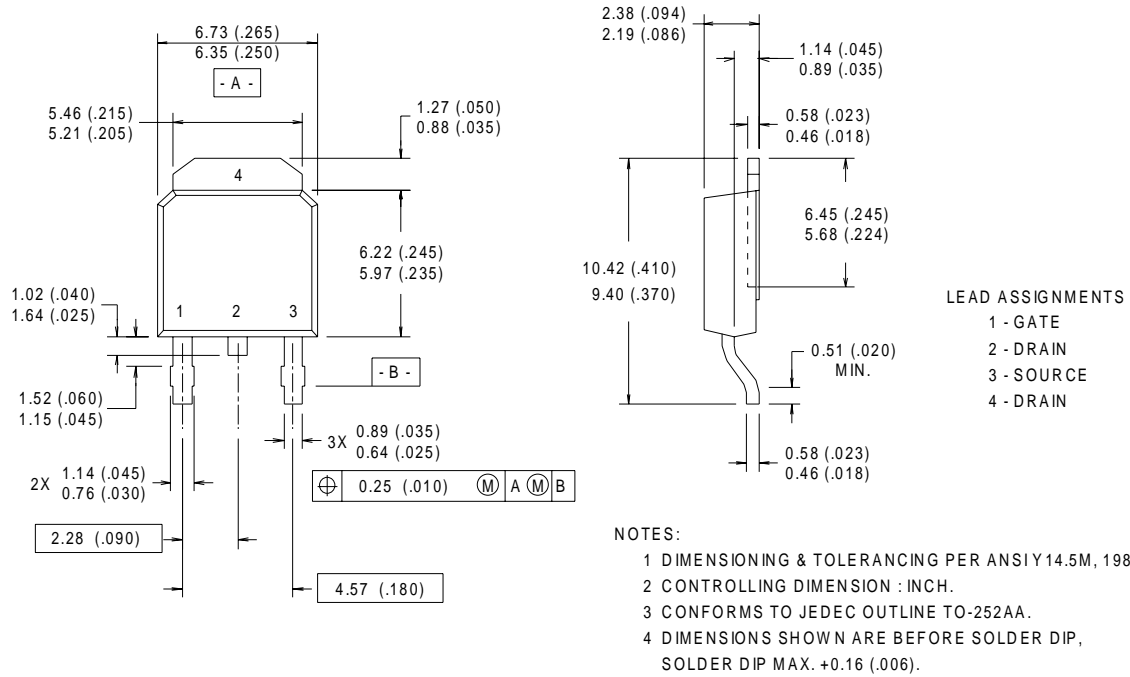
\*\*\*  $V_{GS} = 5.0V$  for Logic Level and 3V Drive Devices

Fig 14. For P-Channel HEXFETS

# IRFR/U5305

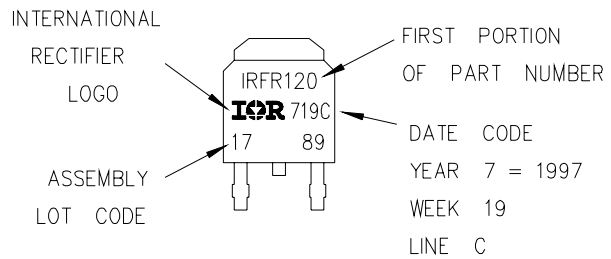
## D-Pak (TO-252AA) Package Outline

Dimensions are shown in millimeters (inches)



## D-Pak (TO-252AA) Part Marking Information

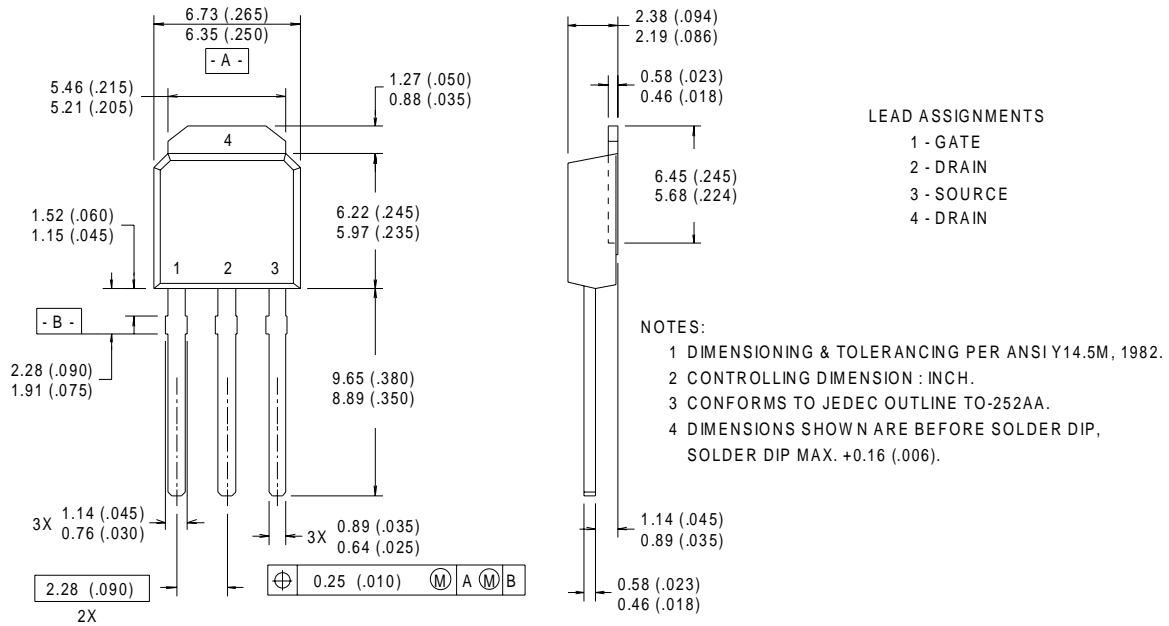
EXAMPLE: THIS IS AN IRFR120  
 LOT CODE 1789  
 ASSEMBLED ON WW 19, 1997  
 IN THE ASSEMBLY LINE "C"





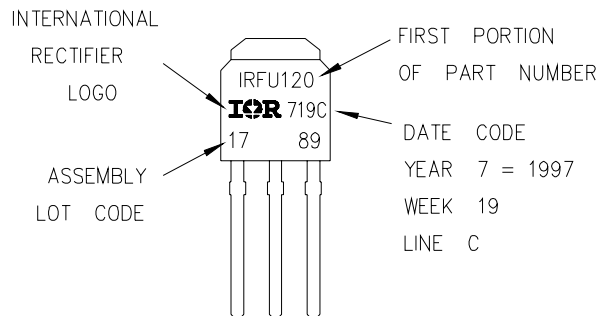
## I-Pak (TO-251AA) Package Outline

Dimensions are shown in millimeters (inches)



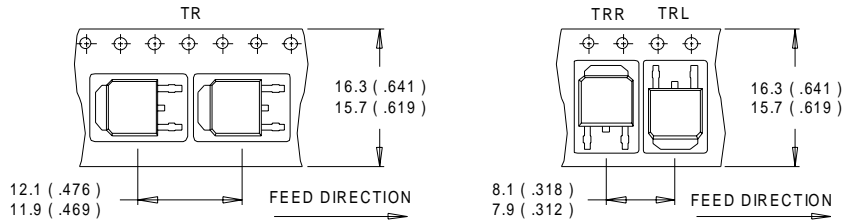
## I-Pak (TO-251AA) Part Marking Information

EXAMPLE: THIS IS AN IRFU120  
 LOT CODE 1789  
 ASSEMBLED ON WW 19, 1997  
 IN THE ASSEMBLY LINE "C"



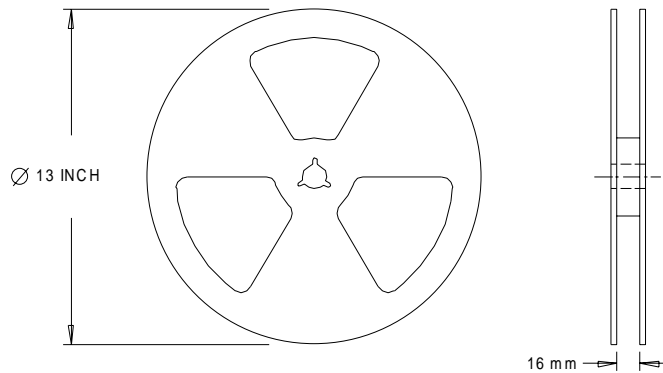
## D-Pak (TO-252AA) Tape & Reel Information

Dimensions are shown in millimeters (inches)



**NOTES :**

1. CONTROLLING DIMENSION : MILLIMETER.
2. ALL DIMENSIONS ARE SHOWN IN MILLIMETERS ( INCHES ).
3. OUTLINE CONFORMS TO EIA-481 & EIA-541.



**NOTES :**

1. OUTLINE CONFORMS TO EIA-481.